



AD2

Handheld Transmitter

User guide for the Shure AD2 Axient Digital handheld transmitter.
Version: 12.2 (2020-K)

Table of Contents

		Menu Map	11
AD2 Handheld Transmitter	3	Menu Parameter Descriptions	11
WARNING	3	Radio Menu	12
AD2 Handheld Transmitter	3	Audio Menu	12
Features	3	Utilities Menu	12
Performance	3	IR Sync	13
Design	4	Setting the Frequency Manually	14
Power	4	Updating Firmware	14
Furnished Accessories	4	Firmware Versioning	14
Choice of one (1) of the following:	4	Updating the Transmitter	14
Optional Accessories	4	RF Mute	15
Optional Shure microphone cartridges:	5	Safe Start	15
AD2 Transmitter Overview	5	Input Overload	15
Transmitter Controls	6	Tone Generator	16
Home Screen Display	6	Matching Audio Levels with Offset	16
Locking the Interface	7	Specifications	16
Batteries	7	Frequency Range and Transmitter Output Level	18
Battery Installation	8	LICENSING INFORMATION	20
Shure Rechargeable Battery	9	Australia Warning for Wireless	21
Checking Battery Info	9	Certifications	21
AA Batteries and Transmitter Runtime	10	Information to the user	22
Installing the Battery Contact Cover	10	Contact Customer Support	23
Menu Parameters	11		
Tips for Editing Menu Parameters	11		

AD2 Handheld Transmitter

WARNING

- Battery packs may explode or release toxic materials. Risk of fire or burns. Do not open, crush, modify, disassemble, heat above 140°F (60°C), or incinerate.
- Follow instructions from manufacturer
- Only use Shure charger to recharge Shure rechargeable batteries
- **WARNING:** Danger of explosion if battery incorrectly replaced. Replace only with same or equivalent type.
- Never put batteries in mouth. If swallowed, contact your physician or local poison control center
- Do not short circuit; may cause burns or catch fire
- Do not charge or use battery packs other than Shure rechargeable batteries
- Dispose of battery packs properly. Check with local vendor for proper disposal of used battery packs.
- Batteries (battery pack or batteries installed) shall not be exposed to excessive heat such as sunshine, fire or the like
- Do not immerse the battery in liquid such as water, beverages, or other fluids.
- Do not attach or insert battery with polarity reversed.
- Keep away from small children.
- Do not use abnormal batteries.
- Pack the battery securely for transport.

Note: Use only with the included power supply or a Shure-approved equivalent.

WARNING: Danger of explosion if incorrect battery replaced. Operate only with AA batteries.

AD2 Handheld Transmitter

AD series hand-held transmitters deliver impeccable audio quality and RF performance with wide-tuning, High Density (HD) mode, and encryption. The transmitter features durable metal construction, AA or Shure rechargeable battery (with dockable charging), and black or nickel finish options.

Features

Performance

- 20 Hz to 20 kHz range with flat frequency response
- Automatic input staging optimizes gain setting
- AES 256-bit encryption-enabled for secure transmission
- >120 dB dynamic range
- 100 meter (300 feet) line-of-sight operating range
- Selectable modulation modes optimize performance for spectral efficiency or audio quality:
 - Standard – optimal coverage, low latency
 - High density – dramatic increase in max system channel count

- Switchable Power Levels = 2/10/35 mW (region dependent)
- Built-in tone generator and RF markers to facilitate range-testing

Design

- Interchangeable Shure microphone cartridges
- Backlit LCD with easy to navigate menu and controls
- Rugged metal construction
- Menu and power lockout

Power

- Up to 8 hours continuous use with 2 x AA alkaline batteries
- Shure lithium-ion rechargeable battery provides extended battery life, precision metering, and zero memory effect
- External charging contacts for docked charging

Furnished Accessories

Zipper Bag	95B2313
Brass Adapter	31B1856
Swivel Adapter, black	90F4046
AA alkaline batteries(2)	80B8201
Battery Contact Cover	WA618

Choice of one (1) of the following:

SM58 (RPW112)	KSM9 Nickel (RPW188)
BETA 87C (RPW122)	BETA 87A (RPW120)
BETA 58A (RPW 118)	KSM9 Black (RPW184)
KSM8 Black (RPW174)	KSM8 Nickel (RPW170)
KSM9HS Black (RPW186)	KSM9HS Nickel (RPW190)

Optional Accessories

Shure Lithium-Ion Rechargeable Battery	SB900A
Radome Color ID Kit for AD2	WA617M
Wireless Microphone Clip	WA371

Optional Shure microphone cartridges:

SM58 (RPW112)
SM86 (RPW114)
SM87A (RPW116)
BETA 58A (RPW118)
BETA 87A (RPW120)
BETA 87C (RPW122)
VP68 (RPW124)
KSM9 Nickel (RPW188)
KSM9HS Nickel (RPW190)
KSM9 Black (RPW184)
KSM9HS Black (RPW186)

AD2 Transmitter Overview

① Microphone Cartridge

See [Optional Accessories](#) for a list of compatible cartridges.

② Display

View menu screens and settings. Press any control button to activate the backlight.

③ Infrared (IR) Port

Align with the receiver IR port during an IR Sync for automated transmitter programming.

④ Menu Navigation Buttons

Use to navigate through parameter menus and change values.

⑤ Battery Compartment

Requires Shure rechargeable battery or 2 AA batteries.

⑥ AA Battery Adapter

Remove to accommodate a Shure rechargeable battery.

⑦ On/Off Switch

Powers the unit on or off.

⑧ Battery Door

Latch to secure batteries.

⑨ Handle

Unscrew to access controls and batteries.

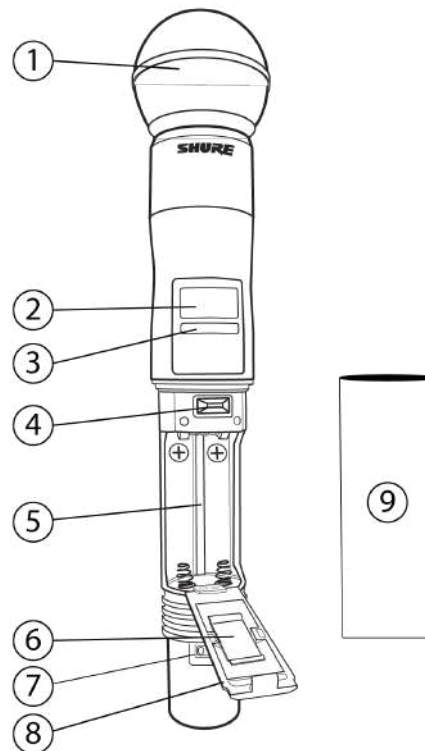

Transmitter Controls

Use to navigate through parameter menus and change values.

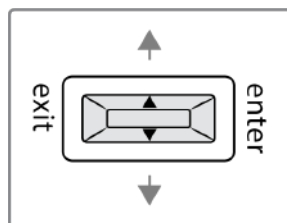

exit	Acts as a 'back' button to return to previous menus or parameters without confirming a value change
enter	Enters menu screens and confirms parameter changes
∧∨	Use to scroll through menu screens and to change parameter values

Tip: Use the following shortcuts for quick setup:

- Hold the \wedge button while powering on to lock or unlock the transmitter controls.
- Hold the exit button while powering on to enter the Safe Start menu.





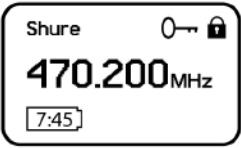

Home Screen Display

The home screen shows transmitter information and status.

There are four pieces of information that you can choose to see on the home screen. Use the arrow buttons to select one of the following choices:

<p>Name Frequency Setting Group (G) and Channel (C) Device ID</p>	
--	--

The following icons indicate transmitter settings:

	Battery runtime in hours and minutes or bar display
	Key: Displayed when encryption is enabled
	Lock: Displayed when controls are locked. Icon will flash if access is attempted to a locked control (power or menu).
	STD: Standard Transmission Mode
	HD: High Density Transmission Mode
	RF Mute Engaged: Displayed when RF output is muted

Locking the Interface

Lock transmitter interface controls to prevent accidental or unauthorized changes to parameters. The lock icon appears on the home screen when a lock is enabled.

1. From the Utilities menu, navigate to Locks and select one of the following lock options:
 - None: The controls are unlocked
 - Power: The power switch is locked
 - Menu: The menu parameters are locked
 - All: The power switch and menu parameters are locked
2. Press enter to save.

Tip: To quickly unlock a transmitter: Press enter twice, select None, and press enter.

Batteries

Battery Installation

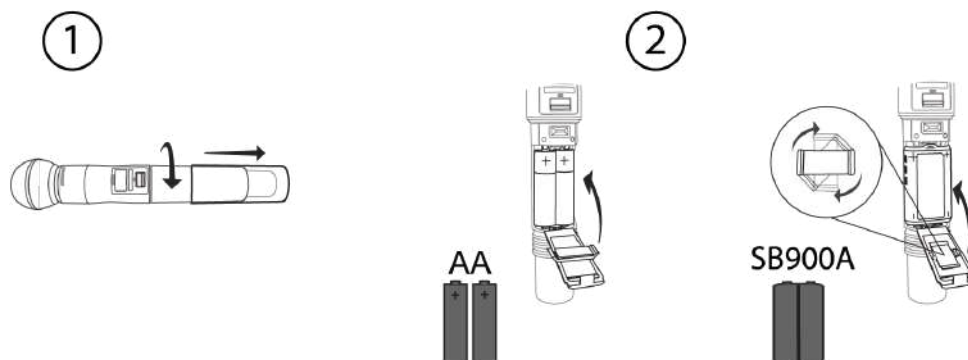

① Accessing the battery compartment	Unscrew the cover on the transmitter as shown to access the battery compartment.
② Installing batteries	<ul style="list-style-type: none"> • AA batteries: Place batteries (note polarity markings) and AA Adapter as shown. Close the door to secure the batteries. • Shure rechargeable battery: Place battery as shown (note polarity markings). Remove the AA adapter and stow it in the door. Close the door to secure the battery. <p>If using AA batteries, set the battery type using the transmitter menu.</p>

Setting the AA Battery Type

To ensure accurate display of transmitter runtime, set the battery type in the transmitter menu to match the installed AA battery type.

If a Shure rechargeable battery is installed, selecting a battery type is not necessary and the battery type will display Shure.

1. Navigate to the Utilities and select Battery.
2. Use the ▼ ▲ buttons to select the installed battery type:
 - Alkaline = Alkaline
 - NiMH = Nickel Metal Hydride
 - Lithium = Lithium Primary
3. Press enter to save.

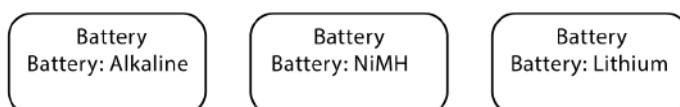

Shure Rechargeable Battery

Shure SB900-series lithium-ion batteries offer a rechargeable option for powering the transmitters. Batteries quickly charge to 50% capacity in one hour and reach full charge within three hours.

Single chargers and multiple bay chargers are available to recharge the Shure batteries. The SB900A rechargeable battery uses SBC200, SBC800 and SBC220 chargers.

Caution: Only charge Shure rechargeable batteries with a Shure battery charger.

Battery Life

	UHF		1.x	
	2 mW/10 mW	35 mW	2 mW/10 mW	30 mW
SB900A	9 hours	4:30 hours	6 hours	5 hours
alkaline	8 hours	3:30 hours	5:30 hours	3:45 hours

The values in this table are typical of fresh, high quality batteries. Battery runtime varies depending on the manufacturer and age of the battery.

Checking Battery Info

When using a Shure rechargeable battery, the receiver and transmitter home screens display the number of hours and minutes remaining.

Detailed information for the battery is displayed Battery menu of the transmitter: **Utilities > Battery**

- **Battery:** The chemistry type of for the installed battery (Shure, Alkaline, Lithium, NiMH)
- **Bars:** Indicates the number of bars displayed
- **Time:** Battery runtime
- **Charge:** Percentage of charge capacity
- **Health:** Percentage of current battery health
- **Cycle Count:** Total of the number of charging cycles for the installed battery
- **Temperature:** Battery temperature reported in Celsius and Fahrenheit

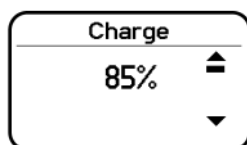

Important Tips for Care and Storage of Shure Rechargeable Batteries

Proper care and storage of Shure batteries results in reliable performance and ensures a long lifetime.

- Always store batteries and transmitters at room temperature
- Ideally, batteries should be charged to approximately 40% of capacity for long-term storage
- Periodically clean the battery contacts with alcohol to maintain ideal contact
- During storage, check batteries every 6 months and recharge to 40% of capacity as needed

For additional rechargeable battery information, visit www.shure.com.





AA Batteries and Transmitter Runtime

Transmitters are compatible with the following AA battery types:

- Alkaline
- Nickel Metal Hydride (NiMH)
- Lithium Primary

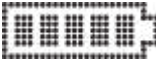
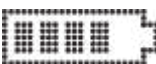
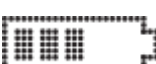
A 5-segment battery indicator representing the charge level of the transmitter battery is displayed on the screens of the transmitter and receiver. The following table contains the approximate remaining transmitter runtime in hours:minutes.

Alkaline Batteries

Battery Indicator	Battery Runtime (hours:minutes)			
	UHF		1.x	
	2 mW/10 mW	35 mW	2 mW /10 mW	30 mW
	8:00 to 6:00	3:30 to 3:00	5:30 to 4:15	3:45 to 3:00
	6:00 to 4:00	3:00 to 2:00	4:15 to 3:00	3:00 to 2:15
	4:00 to 1:45	2:00 to 1:30	3:00 to 1:45	2:15 to 2:00
	<1:45	<1:30	<1:45	<2:00
	<0:45	<0:45	<0:45	<0:45
	<0:15	<0:15	<0:15	<0:15

Installing the Battery Contact Cover

Use battery contact covers to prevent reflections from the battery contacts during broadcasts or live performances.

1. Remove the transmitter handle.
2. Pull gently on the antenna cover to remove. Install a battery contact cover in its place.
3. Reinstall the transmitter handle.

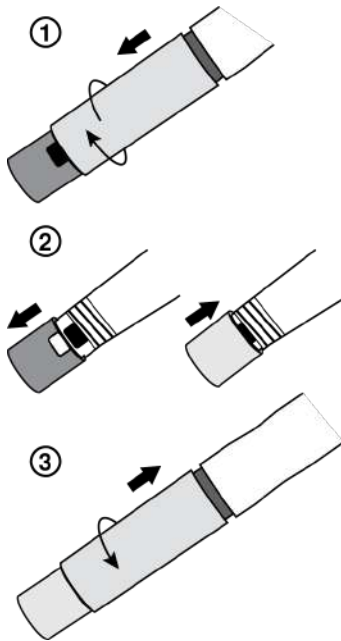

Menu Parameters

The Main menu organizes the available transmitter parameters into three categories:

- Radio
- Audio
- Utilities

Tips for Editing Menu Parameters

- To access the menu options from the home screen, select enter. Select enter again to access the menu parameters.
- A menu parameter will blink when editing is enabled
- To increase, decrease or change a parameter, use the arrow buttons
- To save a menu change, select enter
- To exit a menu without saving a change, select exit

Menu Map

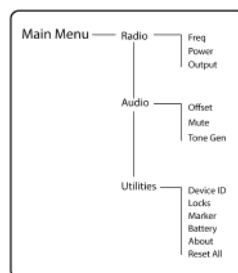

Menu Parameter Descriptions

Radio Menu

Freq

Press the enter button to enable editing of a group (G:) channel (C:) or frequency (MHz). Use the arrow buttons to adjust the values. To edit the frequency, press the enter button once to edit the first 3 digits, or twice to edit the second 3 digits.

Power

Higher RF power settings can extend the range of the transmitter.

Note: Higher RF power settings decrease battery runtime.

Output

Sets the RF output to On or Mute.

- On: RF signal is active
- Mute: RF signal is inactive

Audio Menu

Offset

Adjust Offset level to balance mic levels when using two transmitters or when assigning multiple transmitters to receiver slots. Adjustment range: -12 dB to +21 dB.

Mute

When enabled, the power switch is configured as a mute switch for the audio:

- Power switch on: Audio signal on
- Power switch off: Audio signal muted

Exit mute mode to return the power switch to its normal functionality.

Tone Gen

Transmitter will generate a continuous test tone:

- Freq: The tone can be set to 400 Hz or 1000 Hz.
- Level: Adjusts the output level of the test tone.

Utilities Menu

Device ID

Assign a device ID of up to 9 letters or numbers.

Locks

Locks the transmitter controls and power switch.

- None: The controls are unlocked
- Power: The power switch is locked
- Menu: The menu parameters are locked

- All: The power switch and menu parameters are locked

Marker

When enabled, press the enter button to drop a marker in Wireless Workbench.

Battery

Displays battery information:

- Battery Life: Runtime reported in bar display and time (hours:minutes)
- Charge: Percentage of charge capacity
- Health: Percentage of current battery health
- Cycle Count: Total of the number of charging cycles for the installed battery
- Temperature: Battery temperature reported in Celsius and Fahrenheit

About

Displays the following transmitter information:

- Model: Displays the model number
- Band: Displays the tuning band of the transmitter
- FW Version: Installed firmware
- HW Version: Hardware version
- Serial Num: Serial number

Reset All

Restores all transmitter parameters to factory settings.

IR Sync

Use IR Sync to form an audio channel between the transmitter and receiver.

Note: The receiver band must match the band of the transmitter.

1. Select a receiver channel.
2. Tune the channel to an available frequency using group scan or manually turn to an open frequency.
3. Power on the transmitter.
4. Press the SYNC button on the receiver.
5. Align the IR windows between the transmitter and the receiver so that the IR LED illuminates red. When complete, Sync Success! appears. The transmitter and receiver are now tuned to the same frequency.

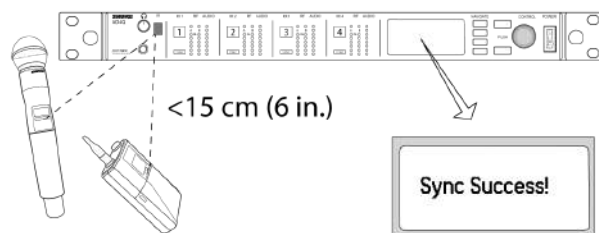

Note:

Any change to the encryption status on the receiver (enabling/disabling encryption) requires a sync to send the settings to the transmitter. New encryption keys for the transmitter and receiver channel are generated on every IR sync, so to request a new key for a transmitter, perform an IR sync with the desired receiver channel.

Setting the Frequency Manually

The transmitter can be manually tuned to a specific group, channel, or frequency.

1. Navigate to the Radio menu and select Freq.
2. Scroll to select G: and C: to edit the group and channel, or select the frequency parameter (MHz). When editing the frequency, press enter once to edit the first 3 digits, or twice to edit the last 3 digits.
3. Use the \wedge \vee buttons to adjust the group, channel, or frequency.
4. Press enter to save, and then press exit when finished.

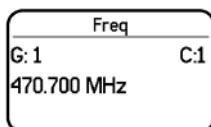

Updating Firmware

Firmware is embedded software in each component that controls functionality. Periodically, new versions of firmware are developed to incorporate additional features and enhancements. To take advantage of design improvements, you can upload and install new versions of the firmware by using the Shure Update Utility. The Shure Update Utility is available for download from <http://www.shure.com/>.

Firmware Versioning

When performing an update, first download firmware to the receiver, and then update transmitters to the same firmware version to ensure consistent operation.

The firmware numbering for Shure devices uses the following format: MAJOR.MINOR.PATCH (e.g., 1.2.14). At a minimum, all devices on the network (including transmitters), must have the same MAJOR and MINOR firmware version numbers (e.g., 1.2.x).

Updating the Transmitter

1. Download the firmware to the receiver.
2. Access the following menu from the receiver: Device Configuration > Tx Firmware Update.
3. Align the IR ports between the transmitter and the receiver. IR ports must be aligned for the entire download, which can take 50 seconds or longer.

The red alignment LED will turn on when the alignment is correct.

4. Press ENTER on the receiver to begin the download to the transmitter. The receiver will display the progress of the update as a percentage.

RF Mute

RF Mute prevents transmission of the audio by suppressing the RF signal while allowing the transmitter to remain on. The home screen displays RF MUTED in this mode.

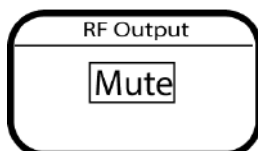

1. From the Radio menu, navigate to Output.
2. Choose one of the following options:
 - On: RF signal is active
 - Mute: RF signal is disabled
3. Press enter to save.

Turning the transmitter off and on or replacing the battery will restore Output to On.

Safe Start

Power on in Safe Start mode to prevent interference with other devices. Hold the exit button while powering on your device until the Safe Start menu appears.

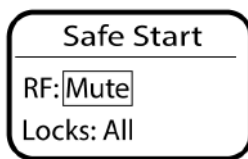

Safe Start menu options:

- RF: Mute or On
- Locks: None, Pwr, Menu, All

Use the navigation buttons to make changes.

Tip: To exit the Safe Start menu, cycle the power or momentarily remove the battery.

Note: Previous settings for locks and RF will be retained when the transmitter is powered on in Safe Start.

Input Overload

The OVERLOAD message is displayed when the audio input experiences a high-level input signal. Reduce the input signal or move mic away from the source to remove the overload.

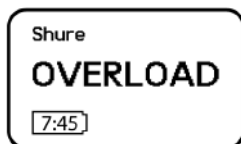

Tone Generator

The transmitter contains an internal tone generator that produces a continuous audio signal. The tone is helpful when conducting a sound check or for troubleshooting the audio signal chain. The level of the tone is adjustable from -60 dB to 0 dB and the frequency can be set to 400 Hz or 1000 Hz.

Tip: Always start with the level set to -60 dB to avoid overloading speakers or headphones.

1. From the Audio menu select Tone Gen.
2. Set the frequency to 400 Hz or 1000 Hz.
3. Select Level and use the arrow buttons adjust the value between -60 dB and 0 dB.

Turn off the tone by selecting Off from the menu or by cycling the transmitter power.

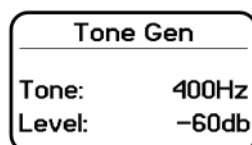

Matching Audio Levels with Offset

When linking two or more transmitters to a receiver, there may be a difference in volume levels between microphones or instruments. If this occurs, use the Offset function to match the audio levels and eliminate audible volume differences between transmitters. If using a single transmitter, set Offset to 0 dB.

1. Turn on the first transmitter and perform a sound check to test the audio level. Turn off the transmitter when finished.
2. Turn on the second transmitter and perform a sound check to test the audio level. Repeat for any additional transmitters.
3. If there is an audible difference in the sound level between the transmitters, navigate to the Offset menu (Audio > Offset) in the transmitter to increase or decrease the Offset in realtime to match the audio levels.

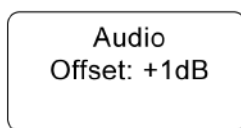

Specifications

Mic Offset Range

-12 to 21 dB (In 1 dB steps)

Battery Type

Shure SB900A Rechargeable Li-Ion or LR6 AA batteries 1.5 V

Battery Runtime

@ 10 mW

Shure SB900A	up to 9 hours
alkaline	up to 8 hours

Dimensions

256 mm x 51 mm (10.1 in. x 2.0 in.) L x Dia.

Weight

340 g (12.0 oz.), Without Battery

Housing

Cast Aluminum

Operating Temperature Range

-18°C (0°F) to 50°C (122°F)

Storage Temperature Range

-29°C (-20°F) to 74°C (165°F)

Audio Input

Configuration

Unbalanced

Maximum Input Level

1 kHz at 1% THD

145 dB SPL (SM58), typical

RF Output

Antenna Type

Integrated Single Band Helical

Occupied Bandwidth

<200 kHz

Channel-to-Channel Spacing

Standard Mode	350 kHz
----------------------	---------

High Density Mode	125 kHz
--------------------------	---------

Modulation Type

Shure Axient Digital Proprietary

Power

2 mW, 10 mW, 35 mW

Specific Absorption Rate (SAR)

< 0.19 W/kg

Frequency Range and Transmitter Output Level

Band	Frequency Range (MHz)	RF Output Power (mW)***
G53	470 to 510	2/10/35
G54	479 to 565	2/10/20
G55†	470 to 636*	2/10/35
G56††	470 to 636	2/10/35
G57	470 to 616*	2/10/35
G62	510 to 530	2/10/35
H54	520 to 636	2/10/35
K53	606 to 698*	2/10/35
K54 Δ	606 to 663**	2/10/35
K55	606 to 694	2/10/35
K56 ◇	606 to 714	2/10/35
K57 Δ	606 to 790	2/10/35
K58	622 to 698	2/10/35
L54	630 to 787	2/10/35
L60	630.125 to 697.875	2/10/35
P55	694 to 703, 748 to 758, 803 to 806	2/10/35
P60	630.125 to 697.875	2/10/35
R52	794 to 806	2/10
JB	806 to 810	2/10
X51	925 to 937.5	2/10

Band	Frequency Range (MHz)	RF Output Power (mW)**
X55	941 to 960	2/10/35
Z16†††	1240 to 1260	2/10/30

*With a gap between 608 to 614 MHz.

**With a gap between 608 to 614 MHz and a gap between 616 to 653 MHz.

***Power delivered to the antenna port.

†Operation mode varies according to region. In Brazil, High Density mode is used. The maximum power level for Peru is 10mW.

††Limited to 10mW for Indonesia.

†††Z16 for Japan only

△ Output power limited to 10 mW above 608 MHz.

◇ Korea defines power as conducted (ERP) which is 1dB less than declared in table.

เครื่องโทรคมนาคมและอุปกรณ์นี้มีความสอดคล้องตามมาตรฐานหรือข้อกำหนดทางเทคนิคของ กสทช.

K55 606-694 MHz

Country Code	Frequency Range
Code de Pays	Gamme de frequences
Codice di paese	Gamme di frequenza
Código de país	Gama de frecuencias
Länder-Kürzel	Frequenzbereich
A, B, BG, CH, CY, CZ, D, DK, EST, F	*
FIN, GB, GR, H, HR, I, IRL, IS, L, LT	*
M, N, NL, P, PL, RO, S, SK, SLO, TR	*
all other countries	*

* This equipment may be capable of operating on some frequencies not authorized in your region. See [Licensing Information](#).

G56 470-636 MHz

Country Code	Frequency Range
Code de Pays	Gamme de frequences
Codice di paese	Gamme di frequenza
Código de país	Gama de frecuencias
Länder-Kürzel	Frequenzbereich
A, B, BG, CH, CY, CZ, D, DK, EST, F	*
FIN, GB, GR, H, HR, I, IRL, IS, L, LT	*
M, N, NL, P, PL, RO, S, SK, SLO, TR	*
all other countries	*

* This equipment may be capable of operating on some frequencies not authorized in your region. See [Licensing Information](#).

K57 606-790 MHz

Country Code	Frequency Range
Code de Pays	Gamme de frequences
Codice di paese	Gamme di frequenza
Código de país	Gama de frecuencias
Länder-Kürzel	Frequenzbereich
A, B, BG, CH, CY, CZ, D, DK, EST, F	*
FIN, GB, GR, H, HR, I, IRL, IS, L, LT	*
M, N, NL, P, PL, RO, S, SK, SLO, TR	*
all other countries	*

* This equipment may be capable of operating on some frequencies not authorized in your region. See [Licensing Information](#).

Please follow your regional recycling scheme for batteries, packaging, and electronic waste.

No user-operated control of power, frequency, or other parameters are available beyond those specified in this operating manual.

LICENSING INFORMATION

Licensing: A ministerial license to operate this equipment may be required in certain areas. Consult your national authority for possible requirements. Changes or modifications not expressly approved by Shure Incorporated could void your authority to operate the equipment. Licensing of Shure wireless microphone equipment is the user's responsibility, and licensability de-

depends on the user's classification and application, and on the selected frequency. Shure strongly urges the user to contact the appropriate telecommunications authority concerning proper licensing, and before choosing and ordering frequencies.

低功率電波輻射性電機管理辦法

第十二條

經型式認證合格之低功率射頻電機，非經許可，公司、商號或使用者均不得擅自變更頻率、加大功率或變更原設計之特性及功能。第十四條

低功率射頻電機之使用不得影響飛航安全及干擾合法通信；經發現有干擾現象時，應立即停用，並改善至無干擾時方得繼續使用。前項合法通信，指依電信法規定作業之無線電通信。低功率射頻電機須忍受合法通信或工業、科學及醫療用電波輻射性電機設備之干擾。

Australia Warning for Wireless

This device operates under an ACMA class licence and must comply with all the conditions of that licence including operating frequencies. Before 31 December 2014, this device will comply if it is operated in the 520-820 MHz frequency band.

WARNING: After 31 December 2014, in order to comply, this device must not be operated in the 694-820 MHz band.

Certifications

Certified under FCC Part 15 and FCC Part 74.

Certified by ISED in Canada under RSS-210.

FCC ID: DD4AD2G55, DD4AD2G57, DD4AD2K53, DD4AD2K54, DD4AD2X55. **IC:** 616A-AD2G55, 616A-AD2K53.

Meets essential requirements of the following European Directives:

- WEEE Directive 2012/19/EU, as amended by 2008/34/EC
- RoHS Directive EU 2015/863

Note: Please follow your regional recycling scheme for batteries and electronic waste

This product meets the Essential Requirements of all relevant European directives and is eligible for CE marking.

Hereby, Shure Incorporated declares that the radio equipment is in compliance with Directive 2014/53/EU. The full text of the EU declaration of conformity is available at the following internet address: <http://www.shure.com/europe/compliance>

Authorized European representative:

Shure Europe GmbH

Headquarters Europe, Middle East & Africa

Department: EMEA Approval

Jakob-Dieffenbacher-Str. 12

75031 Eppingen, Germany

Phone: +49-7262-92 49 0

Fax: +49-7262-92 49 11 4

Email: EMEAsupport@shure.de

- (一) 本产品符合“微功率短距离无线电发射设备目录和技术要求”的具体条款和使用场景；
- (二) 不得擅自改变使用场景或使用条件、扩大发射频率范围、加大发射功率（包括额外加装射频功率放大器），不得擅自更改发射天线；
- (三) 不得对其他合法的无线电台（站）产生有害干扰，也不得提出免受有害干扰保护；
- (四) 应当承受辐射射频能量的工业、科学及医疗（ISM）应用设备的干扰或其他合法的无线电台（站）干扰；

(五) 如对其他合法的无线电台（站）产生有害干扰时，应立即停止使用，并采取措施消除干扰后方可继续使用；

(六) 在航空器内和依据法律法规、国家有关规定、标准划设的射电天文台、气象雷达站、卫星地球站（含测控、测距、接收、导航站）等军民用无线电台（站）、机场等的电磁环境保护区域内使用微功率设备，应当遵守电磁环境保护及相关行业主管部门的规定。

Information to the user

This device complies with part 15 of the FCC Rules. Operation is subject to the following two conditions:

1. This device may not cause harmful interference.
2. This device must accept any interference received, including interference that may cause undesired operation.

Note: This equipment has been tested and found to comply with the limits for a Class B digital device, pursuant to part 15 of the FCC Rules. These limits are designed to provide reasonable protection against harmful interference in a residential installation. This equipment generates uses and can radiate radio frequency energy and, if not installed and used in accordance with the instructions, may cause harmful interference to radio communications. However, there is no guarantee that interference will not occur in a particular installation. If this equipment does cause harmful interference to radio or television reception, which can be determined by turning the equipment off and on, the user is encouraged to try to correct the interference by one or more of the following measures:

- Reorient or relocate the receiving antenna.
- Increase the separation between the equipment and the receiver.
- Connect the equipment to an outlet on a circuit different from that to which the receiver is connected.
- Consult the dealer or an experienced radio/TV technician for help.

This device operates on frequencies shared with other devices. Consult the Federal Communications Commission White Space Database Administration website to determine available channels in your area prior to operation.

Canada Warning for Wireless

This device operates on a no-protection, no-interference basis. Should the user seek to obtain protection from other radio services operating in the same TV bands, a radio licence is required. For further details, consult Innovation, Science and Economic Development Canada's document Client Procedures Circular CPC-2-1-28, Voluntary Licensing of Licence-Exempt Low-Power Radio Apparatus in the TV Bands.

Ce dispositif fonctionne selon un régime de non-brouillage et de non-protection. Si l'utilisateur devait chercher à obtenir une certaine protection contre d'autres services radio fonctionnant dans les mêmes bandes de télévision, une licence radio serait requise. Pour en savoir plus, veuillez consulter la Circulaire des procédures concernant les clients CPC-2.1.28, Délivrance de licences sur une base volontaire pour les appareils radio de faible puissance exempts de licence et exploités dans les bandes de télévision d'Innovation, Sciences et Développement économique Canada.

This device contains licence-exempt transmitter(s)/receiver(s) that comply with Innovation, Science and Economic Development Canada's licence-exempt RSS(s). Operation is subject to the following two conditions:

1. This device may not cause interference.
2. This device must accept any interference, including interference that may cause undesired operation of the device.

L'émetteur/récepteur exempt de licence contenu dans le présent appareil est conforme aux CNR d'Innovation, Sciences et Développement économique Canada applicables aux appareils radio exempts de licence. L'exploitation est autorisée aux deux conditions suivantes :

1. L'appareil ne doit pas produire de brouillage;
2. L'appareil doit accepter tout brouillage radioélectrique subi, même si le brouillage est susceptible d'en compromettre le fonctionnement.

Contact Customer Support

Didn't find what you need? [Contact our customer support](#) to get help.